

# Wireless Intelligent Alarm System

Quick Operation Manual

(Version: V2.1)



Please read this installation and use manual carefully before use for proper installation and fast operation. Please refer to the actual product in case of any difference in product appearance or color!

## I. Brief Introduction

The alarm system is a secure and efficient wireless alarm system protecting people and property promptly indicating any attempt of intrusions by means of audible and visual alarms and with auto calls and SMS message. The system consists of a programmable control panel to monitor and can supervise different kinds of wireless sensors, such as motion sensor, door magnetic sensors and so on for internal protection.

### 1.1 Features

- 99 wireless zones
- Support up to 99 wireless sensors;
- Support up to 16 remote controls
- Store up to 6 numbers for SMS/call alarm
- Voice memo
- Arm and disarm by SMS or phone call
- Remote voice monitor by phone
- SMS alert for power failure, power recovery and low battery
- Built-in 1000mA battery offer up to 10 hours standby.
- Android & IOS APP Control

### 1.2 Specifications

- 1) Radio frequency: 433.92MHz
- 2) GSM frequency: 850/900/1800/1900MHz
- 3) Working power
  - Power voltage input: 5V 2A
  - Standby battery: 1000mAh
  - Standby time: ≥10 hours
- 4) Working conditions
  - Temperature: -20-60°C Humidity: ≤95 %

### 1.3 Standard Accessories



PIR motion Sensor



Window/Door Sensor



Siren



Remote control



Adapter(UL/CE)



Manual



Fixing Support

These pictures are only for reference. Please refer to actual accessories!

## II. Functions

### 1) Sensor & Zone :

System is designed with 99 wireless zones. Each zone can be paired with one sensor. All sensors can be learned as 4 different zone mode:

\* **Normal zone:** The sensors of normal zone work according to the arm and disarm settings. They will trigger the alarm immediately after some abnormalities are detected in the status of arm.

\* **24-hour emergency zone:** Disarming the sensors of 24-hour zone is impossible. Smoke, gas or broken glass sensor is recommended.

\* **Delay arm zone:** The sensors of delay arm zone would delay its execution of arming and giving an alarm respectively for 30 seconds by default. The alarm can be canceled if you disarm in this period of time. The delay time can be changed. See the List of SMS Commands for details.

\* **Part of zone arming:** It is also called **Home mode Arm**. If panel is in part of zone arming status, this kind of sensors would not trigger an alarm, other sensors work normally.

### 2) Remote Monitoring

Remote monitoring is activated on every alarm or by calling the control panel to enter monitoring/communication status.

### 3) Emergency Alarm

Press the SOS button on panel or remote control can trigger the Emergency alarm function. The siren will make sound, SMS and phone calls will be made as programmed.

### 4) Power Status Alarm

SMS Alert will be sent when the external power is disconnected or recovered, also for low

battery situation.





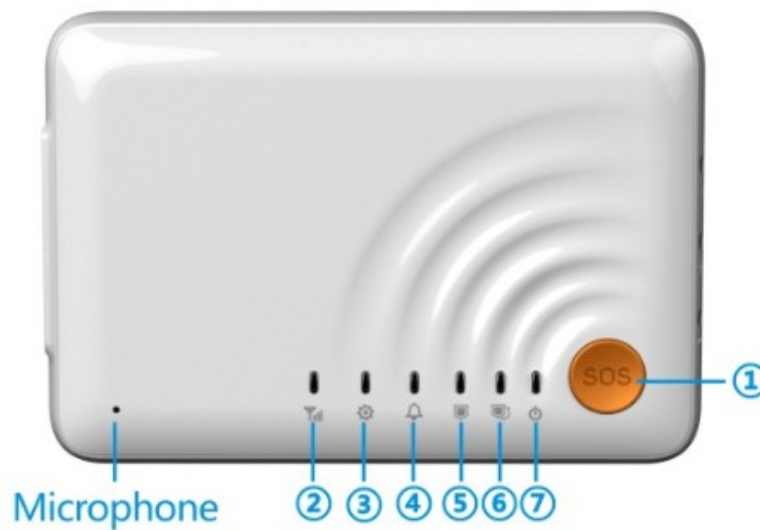

### 5) Voice Memo

System supports 10 seconds voice memo recording by pressing the record button on the panel.

The voice memo will play after the user picks up the calling of alarm.

### III. Appearance







 SOS button	Long press this button for 3 seconds will trigger the SOS alarm. The panel will send SMS "installation address + emergency alarm, attention please" to the SOS number, then the siren hoots.
 GSM signal indicator	Blink slowly: GSM signal is normal; Continuous lighting: No GSM signal or SIM card.
 Setting indicator	It's on after pressing the "Set" button to enter setting status..
 Alarm indicator	It's on when alarm happens.
 Arming indicator	It blinks slowly if panel is in Arming status.
 Part of zone arming indicator	It blinks slowly if panel is in part of zone arming status.



 Power indicator	It is on if external power is connected and off if external power is disconnected.
---	--

## Indicators under Setting

After short pressing the “Set” button, the panel enters into setting status. Press switch button to select the zone mode for sensors; Besides the voice prompt, the indicator can show the current status as follows :

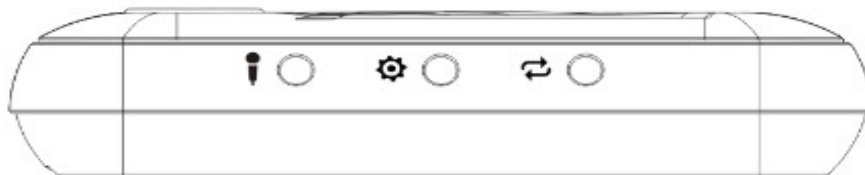
 The GSM and Setting indicators are on at the same time.	The system is learning the remote control.
 The Setting and Alarm indicators are on at the same time.	The system is learning the sensors as normal sensor.
 The Alarm and Arming indicators are on at the same time.	The system is learning the sensors as 24-hour emergency arm sensor.
 The Arming and Part of zone arming indicators are on at the same time.	The system is learning the sensors as delay arm sensor.
 The Part of zone arming indicator and Power indicators come on at the same time.	The system is learning the sensors as part of zone arming sensor.



 Record button	For voice recording
 Set button	For enter setting status
 Switch button	For switching among learning modes

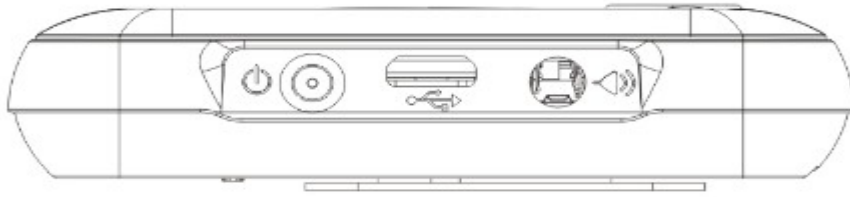

Power Port

USB Interface

Siren Interface

## **IV. Installation**

### **4.1 Installation of SIM card**

Prepare a SIM card applicable to GSM phone (its functions of normal conversation and text message receiving and sending must be guaranteed).

Switch off the panel power and open the back battery cover, and then insert the prepared SIM card into its holder according to the direction shown. The installation is completed.

### **4.2 Connect with Siren**

The way of connection is as below:

1. Connect the siren to the interface in the bottom left of the device;
2. Boot up the device:

Plug in the power and then switch on the panel, and then all indicators on the panel keep on and will return to normal status in 20 seconds.

### **4.3 Installation of Panel**

- ① Fix the fixing support on the wall with screws or 3m foam glue.

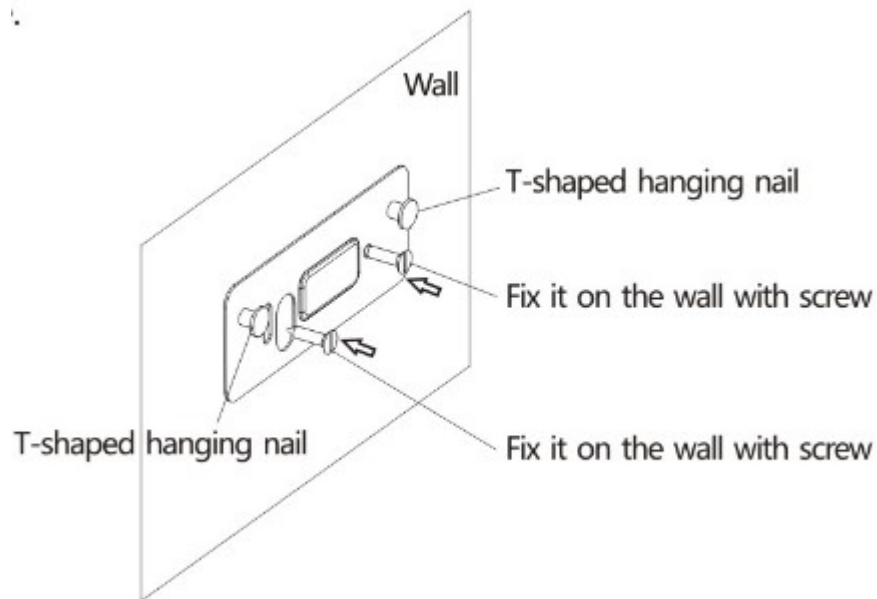

② Aim the two T-shaped holes on the back of panel at the T-shaped hanging nails on fixing support, and then hang the panel on the two nails as shown in the picture below.

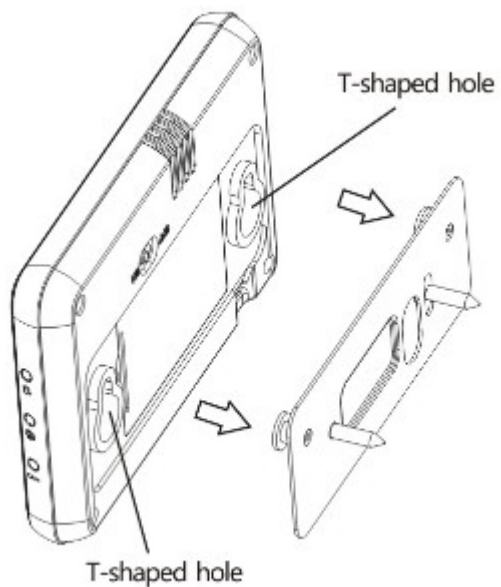

#### 4.4 Window/door Sensor Installation



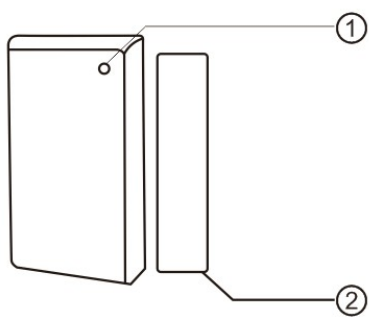

Alarm indicator: it blinks when sounding an alarm.

**Installation**

**diagram**

Magnet: Cooperate with door sensor switch to sound alarms. Their installation positions are shown in the left picture (the magnet must be on the right). The door sensor switch will sound an alarm when the magnet gets away from the door sensor.

The installation position of window/door sensor should be determined according to the minimum angle in which the door can be opened. The distance between magnet and sensor should not exceed 10mm. The magnet and the transmitter should be installed on door and door frame respectively.

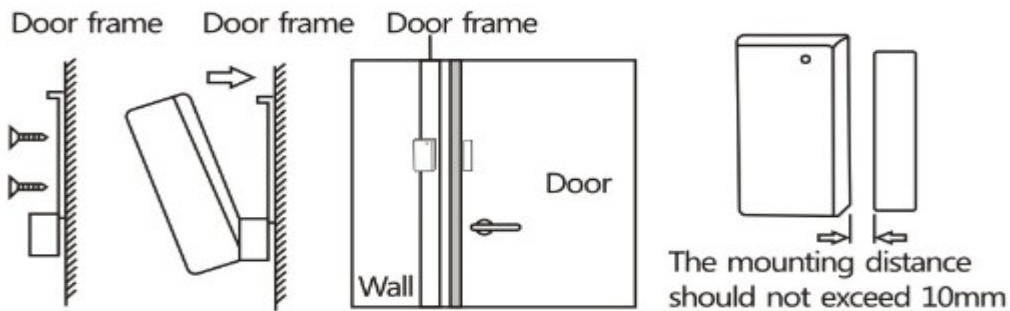

**4.5 PIR Motion Sensor Installation**

Please refer to the manual of PIR motion sensor.

**V. Pairing Accessories**

**5.1 Pair Remote Control**

Please confirm the panel is in the status of disarming before setting.



①Please press “Set” button into learning status.  
 If no remote control has been paired, panel will give a voice prompt of “Remote control learning mode”;  
 If any remote control has been paired, you will hear “Press any button in paired remote control”.

②The panel will beep once after short pressing any button on the remote control.

③ Then, long press the SOS button on the panel to save (short press the SOS button to cancel); the panel will send a voice prompt of “Successful pairing” after learning remote control is completed.

**Notice:**

The panel supports up to pair with 16 remote controls. It can automatically sort these remote controls according to their

pairing times. To avoid confusion, please well mark these remote controls.

**5.2 Pair Sensors**

Please pair remote controls before pairing of sensors.

Up to 99 sensors can be placed in the following four zone mode according to different requirements.



①Press “Set” button enter setting status with voice prompt that “Press any button in paired remote control”.

②Press any button of the remote control paired, the panel will send a voice prompt of “Remote control learning mode”.

③ Then, press the Switch button on the panel, you will hear voice prompts of “Normal zone”, “24-hour emergency zone”, “Delay arm zone” and “Part of zone arming” in succession.

④ Trigger the sensor after hear the zone mode you want to pair the sensor, then the panel will beep once if success.

⑥ Then, you can go on other sensor pairing or press switch button to transfer other zone mode for pairing.

⑦ After completion of learning, press the disarm button on the remote control or “Set” button to exit. Or panel will auto exit after 30 seconds without any operations.

**Notice:**

1) There is a voice prompt of “**Been paired!**”, if the remote control or sensor was paired before;

2) If the sensor is full in this kind of zone mode( Up sensors), the control panel will make a voice prompt: “**The line is full!**”

3) Sensors with fix code cannot be programed with code when pairing to the same panel.

⑤ Long press the SOS button on the panel to save. After the learning is completed, the panel will send a voice prompt “**Successful pairing**”.

to 99 same



## VI. SMS Setting Commands

The letters in command are not case-sensitive, but the comma must be in English format.

### 6.1 SOS Number

Only SOS numbers have the authority to remotely control the device.

SOS number could be added by SMS from any mobile phone:

**SOS,A,type of alarm,phone number,phone number,phone number,phone number,phone number,phone number #**

Type of alarm: 1 = dialing alarm, 2 = SMS alarm, 3 = SMS + Dialing alarm (default)

For example, SOS, A, 3, 35106xxx69, 35116xxx79, 36126xxx89, 36126xxx99, 35106xxx09, 35106xxx72#

If require of different numbers with different alarm ways, the SMS command format should be:

**SOS,A(1~6),type of alarm,phone number#**

For example,

SOS, A1, 3, 35106xxxx1# --means the 1<sup>st</sup> SOS number is set; type of alarm: SMS + dialing;

SOS, A2, 2, 35116xxx13# -- means the 2<sup>nd</sup> SOS number is set; type of alarm: SMS;

SOS, A5, 1, 35106xxx33# -- means the 5<sup>th</sup> SOS number is set; type of alarm: dialing;

### **Delete SOS Number**

Delete by SMS from SOS phones:

**SOS,D,number order1,number order2,number order3#**

“D” means deleting SOS number

**SOS,D,1#**----deleting the first phone **number**

**SOS,D,2#**----deleting the second phone number

**SOS,D,3#**----deleting the third phone number

Delete several numbers at one time:

**SOS,D,1,3#**---- deleting the first and third phone number

Delete phone number directly:

**SOS,D,phone number#**---- deleting the SOS phone number

For example:

**SOS,D,3500000002#**---- delete the SOS phone number, 3500000002

## **6.2 Arming/Disarming**

6.2.1 If arm/disarm by SMS, please refer to the chapter “SMS Commands”.

6.2.2 If arm/disarm by remote control, please refer to the section of “Remote Control Operation”.

6.2.3 If arm/disarm by phone call, please refer to the section of “Program the panel by phone call”.

### **6.3 Operation of Super Command**

Non-SOS numbers can send super command to remote control the panel freely.

SMS format: password, command#

For example: send a command of “**1234, ARM#**” to the panel for arming.

Send a command of “**1234, PWD, 88888#**” to change the password, then, the new password is 88888.

## **VII. Program the Panel by Phone Call**

Users can use a SOS number to call the panel for remotely control the panel, the panel will automatically get through the call after long beeping twice and feedback a voice prompt of the operation:

- 1) Press 1: Remote Voice Monitoring
- 2) Press 2 :Announce
- 3) Press 3: Close Remote Voice Monitoring & Announce
- 4) Press 4: Siren Ringing
- 5) Press 5 : Siren Closed
- 6) Press 6 : Arm
- 7) Press 7 : Home Mode Arm
- 8) Press 8: Disarm
- 9) Press 9: Listen again

## **VIII. Operations**

## 8.1 Remote Control Operation

Arm:  Press arm button, the panel beeps once and the arming indicator begins to blink.

Disarm:  Press disarm button, the panel beeps once, the arming indicator turns off and panel enters the status of disarming.

Part of zone arming :  Press part of zone arming button, the panel beeps once, the part of zone arming indicator blinks, and panel enters the status of home mode arm.

Emergency alarm:  Press SOS button, the panel will enter emergency alarm status, trigger the siren and start the SMS/Dialing alert to SOS number. Alarm indicator turns on.

## 8.2 Alarm Receiving and Handling

After giving an alarm, the panel sends SMS alert first, and then makes the call to SOS numbers if there is no disarm operation. Calling alert will stop if the call is answered, or it will circle call the SOS numbers programmed with dialing alert for three times.

During the alert time, you can disarm the panel by SMS, remote control or answer the alter calling.

## IX. Installation and Use Notes

- 1 . Never make water into the panel.
- 2 . The panel should be installed in a concealed location but in which the network signal must be strong.
- 3 . Please turn off the power in removing or installing the card.
- 4 . The power supply should be connected firmly with good heat dissipation.
- 5 . The panel will enter the normal operation in 20 seconds after starting up.

- 6 . The batteries of all sensors should be checked regularly and replaced timely in case of low power.
- 7 . Never make the infrared sensor directly face a window in installing.
- 8 . Don't install this device close to objects with strong electromagnetic interference such as TV, computer, etc.
- 9 . Please check the panel's SIM card (in terms of network signal, charges) frequently and regularly.

## X. SMS Commands

### 1. SOS Alarm Number

FUNCTION	COMMAND	REPLY	EXPLANATION
<b>Add SOS alarm number</b>	(a) <b>SOS,A,mode,P1,P2,P3,P4,P5,P6#</b> (b) <b>SOS,A(No.),mode,P#</b>	Set Successfully! SOS1: 00185123 SOS2: SOS3: SOS4: SOS5: SOS6:	mode: 1 means dial, 2 means SMS, 3 means dial+SMS; P(No.): <b>3~20</b> (Byte); A1 means the first SOS1.
	Eg: (a) <b>SOS,A,3,001858123#</b> (b) <b>SOS,A1,3,00185123#</b>		
<b>Delete SOS alarm number</b>	(a) <b>SOS,D,P1,P2,P3,P4,P5,P6#</b> (b) <b>SOS,D,1,2,3,4,5,6#</b>	Set Successfully! SOS1: SOS2: SOS3: SOS4: SOS5: SOS6:	
	Eg: (a) <b>SOS,D,001858123,001857456#</b> (b) <b>SOS,D,1#</b>		
<b>Check SOS alarm number</b>	<b>QSOS#</b>	SOS1: 00185123 ,Type:3 SOS2: ,Type: 0 SOS3: ,Type: 0 SOS4: ,Type: 0 SOS5: ,Type: 0 SOS6: ,Type: 0	

### 2. Remote Control Setting

FUNCTION	COMMAND	REPLY	EXPLANATION
<b>Delete one paired</b>	<b>DR,NO.#</b>	Clear success!	NO.:01~16;

remote control	Eg:DR,02#		
Delete all paired remote controls	DRA#	Clear success!	
Set the name of one remote control	EDITR,NO.,remote control name#	Set success! 01: Room 01	NO.:01~16; Remote control name:0~9(Byte);
	Eg:EDITR,01,Room01#		
Check the name and serial number of the remote control	QR,NO.#	01:201110220010-Room01	NO.:01~16; Remote control name:0~9(Byte); 201110220010 is Remote ID.
	Eg: QR,01#		
Check the name and serial number of all remote controls	QRA#	01:201110220010-Room1 02: 03:	

### 3. Sensor Setting

FUNCTION	COMMAND	REPLY	EXPLANATION
Delete one paired sensor	DF,Zone NO.#	Clear success!	Zone NO.:01~99;
	Eg:DF,05#		
Delete all paired sensors of one zone mode	DFA,Zone mode#	Clear success!	Zone mode: 0 means <b>normal zone</b> , 1 means <b>24-hour emergency zone</b> , 2 means <b>delay arm zone</b> , 3 means <b>part of zone arming</b> , A means <b>all zones</b> ;
	Eg: DFA,0#		
Set the zone name of one sensor	EDITM,Zone NO.,Zone name#	Zone name changed ! Zone05:home 01	Zone NO.:01~99; Zone name:0~20(Byte);
	Eg:EDITM,05,home 01#		
Check the zone mode and attributes of one sensor Check all sensors of one specified	QF,Zone NO.#	01:0-001221200110	Zone NO.:01~99;
	Eg: QF,01#		
	QFA,Zone mode#	01:0-001221200110 02:0-222222222222	Zone mode: 0 means <b>normal zone</b> ,



zone mode	Eg: QFA,0#		1 means <b>24-hour emergency zone</b> , 2 means <b>delay arm zone</b> , 3 means <b>part of zone arming</b> , A means <b>all zones</b> ;
Change the zone mode of one sensor	EDITS,Zone NO.,Zone mode#	Set success! 01:1-001221200110	Zone NO.:01~99; Zone mode: 0 means <b>normal zone</b> , 1 means <b>24-hour emergency zone</b> , 2 means <b>delay arm zone</b> , 3 means <b>part of zone arming</b> , A means <b>all the zones</b> ;
	Eg: EDITS,01,1#		

#### 4. Arm/Disarm

FUNCTION	COMMAND	REPLY	EXPLANATION
Set all sensors arm	ARM#	System Armed!	
Set all sensors disarm	DISARM#	System Disarmed!	
Set part of zone arming	STAYARM#	Home Mode Alarm is armed!	

#### 5. Delay Arm setting

FUNCTION	COMMAND	REPLY	EXPLANATION
Set the time of delay arm	DLY, P1 delay arm time,P2 buzzer sounds length,P3 delay alarm time#	Arm delay: 0 s Siren time: 90 s Alarm delay: 0 s	P1:0~240 s; P2:10~300s; P3:0~240s; Default:0,90,0;
	Eg: DLY,0,90,0#		
Check the setting of delay alarm	QDLY#	Arm delay: 0 s Siren time: 90 s Alarm delay: 0 s	P1:0~240 s; P2:10~300s; P3:0~240s; Default:0,90,0;

### 7. Set Password of the Panel

FUNCTION	COMMAND	REPLY	EXPLANATION
Change password	PWD,P1#	New password: 654321	P1:4~9(Byte); Default:1234;
	Eg: PWD,654321#		

### 8. The Installation Address of the Panel

FUNCTION	COMMAND	REPLY	EXPLANATION
Set the installation location of panel	AD, Defined Address #	Location changed!	Defined Address: 0~99(Byte);
	Eg: AD,Wal-Mart's fourth floor area #	Location: <i>Wal-Mart's fourth floor area.</i>	
Check the location of panel	QAD#	Location: <i>Wal-Mart's fourth floor area.</i>	

### 9. SMS Reply of Remote Control Operation

FUNCTION	COMMAND	REPLY	EXPLANATION
Enable SMS reply of remote control operation	CTRON#	Set success! SMS reply of remote controller: On	
Disable SMS reply of remote control operation	CTROFF#	Set success! SMS reply of remote controller: Off	
Check SMS reply state of remote control operation	QCTR#	SMS reply of remote controller:On/Off	

### 10. Siren Sound State of Remote Control Operation

FUNCTION	COMMAND	REPLY	EXPLANATION
Enable the siren sound when remote control works	CSON#	Set success! When remote control set arm / disarm ,the siren sound state: On	

Disable the siren sound when remote control works	CSOFF#	Set success! When remote control set arm / disarm ,the siren sound state: Off	
Check siren sound state	CSQ#	When remote control set arm / disarm, the siren sound state: On/Off	

### 11. Power Failure/Recovery alarm

FUNCTION	COMMAND	REPLY	EXPLANATION
Enable power failure/recovery alarm	CA,ON#	Set success!: On	
Disable power failure/recovery alarm	CA,OFF#	Set success!: Off	
Check the state of power failure/recovery alarm	CA,Q#	Status: On/Off	

### 12. Check Status of the Panel

FUNCTION	COMMAND	REPLY	EXPLANATION
Check status	STATUS#	System status: Disarmed Password: 1234 SMS reply of remote controller: Off Charger disconnected CHARGER OUT ALARM:Off IMEI:864717002620288	

### 13. Reboot

FUNCTION	COMMAND	REPLY	EXPLANATION
Reboot	REBOOT#	Device will reboot in 30s.	

### 14. Restore to Factory Status

FUNCTION	COMMAND	REPLY	EXPLANATION
----------	---------	-------	-------------

Restore	RESTORE#	Device will restore in 30s.	
---------	----------	-----------------------------	--

## XI. Troubleshooting

Please refer to the following troubles and solutions in case of any abnormalities in operating.

If any problem still cannot be solved, please contact your product distributor or service provider.

COMMON TROUBLES	CAUSE	SOLUTION
<b>Failure to boot up</b>	No external power or the battery has run out.	Connect to an external power supply.
<b>Failure to monitor</b>	The panel hasn't set SOS number. Only SOS number has the authority to control the device.	Set the SOS number.
	The caller ID service of SIM card isn't available.	Enable the caller ID display function of the SIM card.
<b>Unable to connect to the network</b>	The SIM card isn't installed properly.	Check the SIM card.
	There is some dirt on the SIM card's metal face.	Wipe with a clean cloth.
	The SIM card is invalid.	Contact your network service provider.
	The device is out of the GSM service area.	Please move the device to the service area of your network service provider.
	The signal is weak.	Please move the device to a place with strong signals and try again.
<b>Unable to charge</b>	The charging voltage is not consistent with that stated on the charger.	Please charge with a voltage consistent with that stated on the charger.
	Using a not standard charger.	Please use the standard charger provided by manufacturer.
	Poor contact	Check the connection of plug.
<b>The sensor cannot send alarms</b>	Out of the transmission range.	Install the device within the transmission range.
	The battery has run out.	Replace with a new battery.

	The panel doesn't arm.	Arming
--	------------------------	--------