

4 Cameras Power From Cable Hub Station

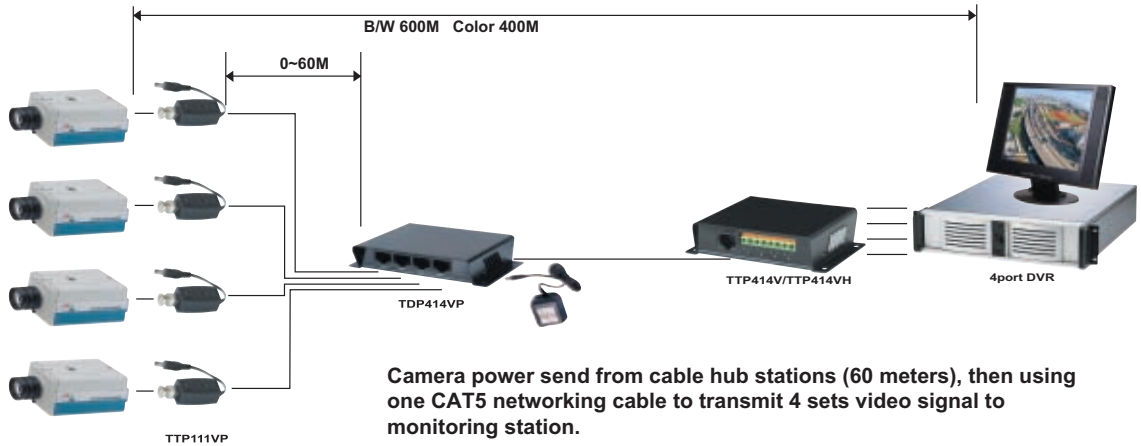

4 Cameras to Hub CCTV Distribution Application

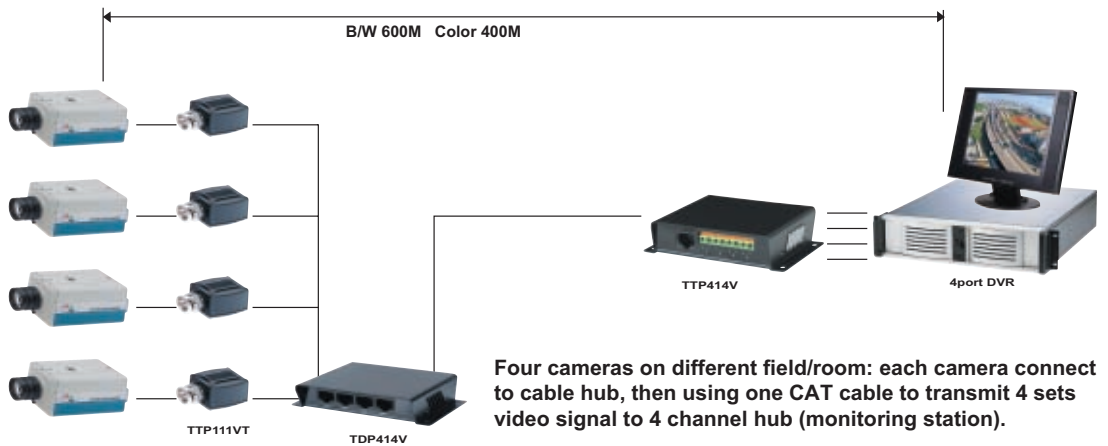

4 Channel Hub to Hub CCTV Distribution Application

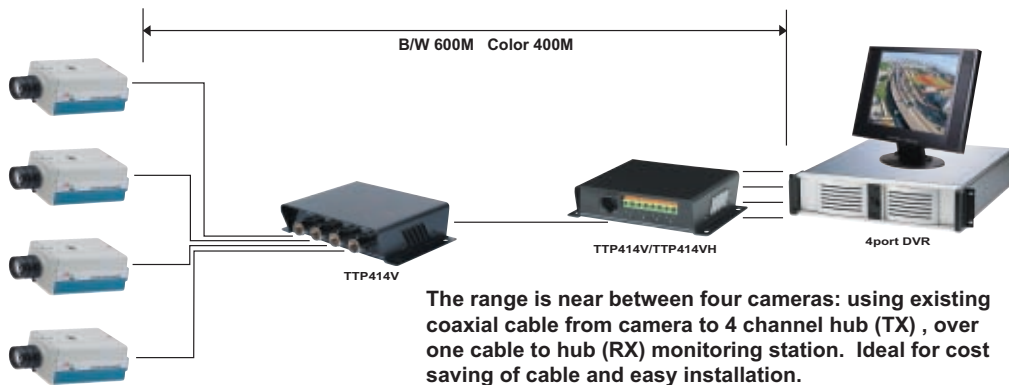

Speed Dome Camera Application

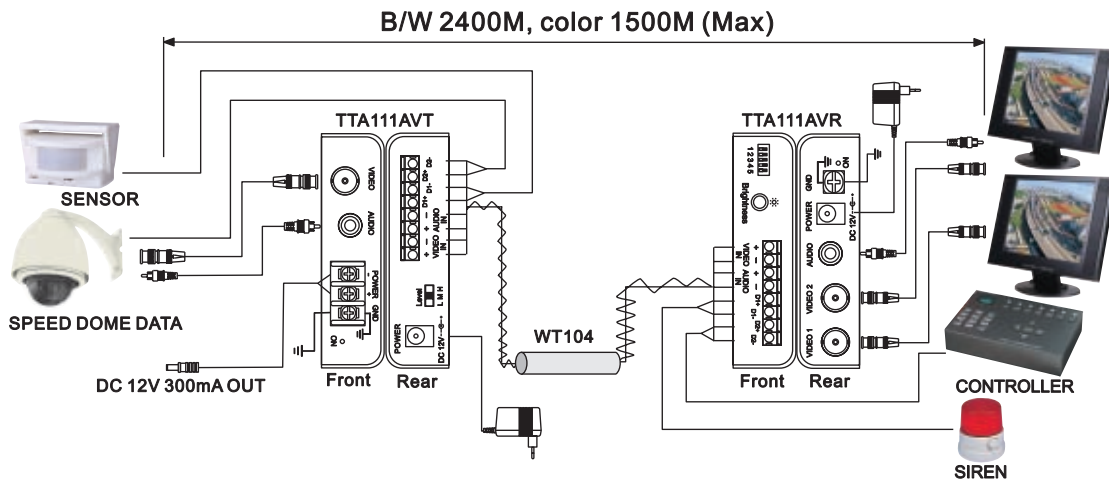

Using TTA111AV could transmit video, audio, 2 data signal, range up to 1.5KM (Color), 2.4Km (B/W)

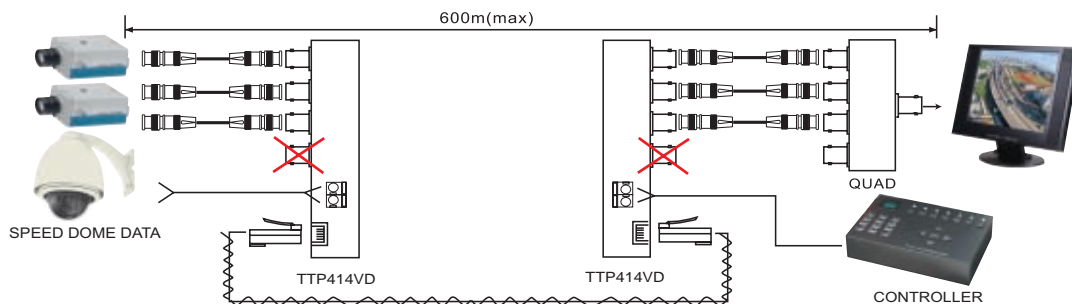

Using one 4 pair UTP cable to transmit/receive 4 sets video signals or use 3 pairs to transmit/receive 3 sets video signal, plus one data signal (RS422,485).

One Cable For Variety Range Application

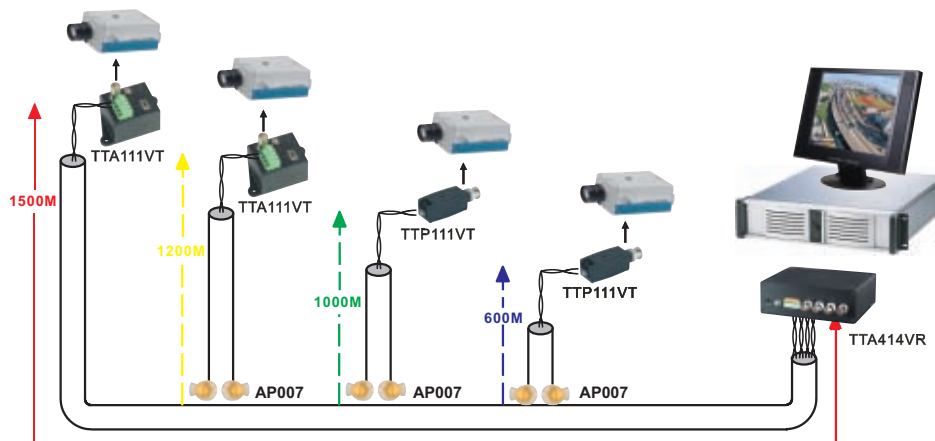

Passive or active video transceiver for series connection to use one CAT5 4 pairs cable, transmit 4 video signals for different range.

Video, Power, Data Transmission Application

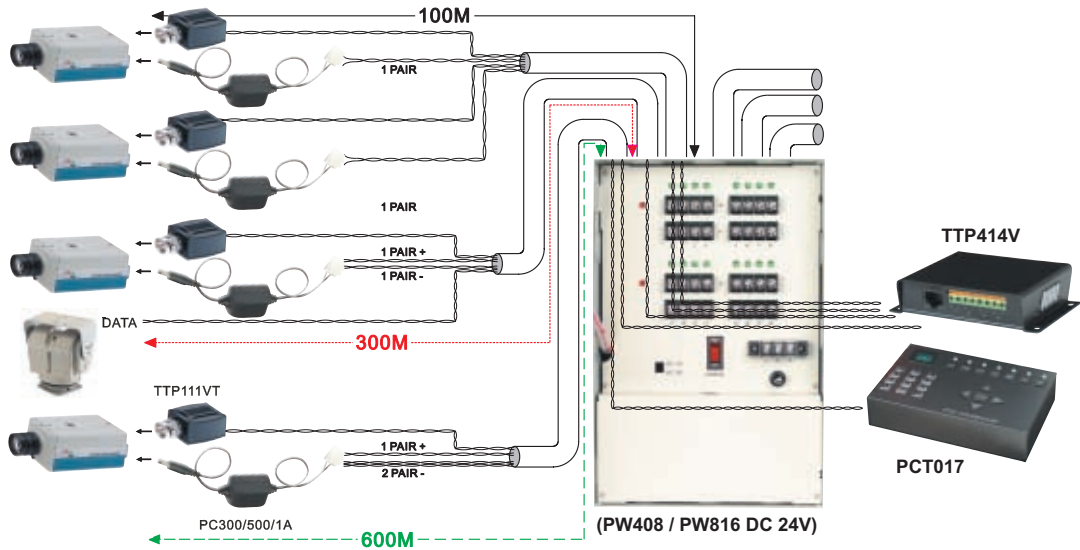

Using CAT 5 cable to transmit Video, Power, Data Signal for best & professional cabling management.

Multi-Port 8 or 16 Channel Multiplexer / DVR Application

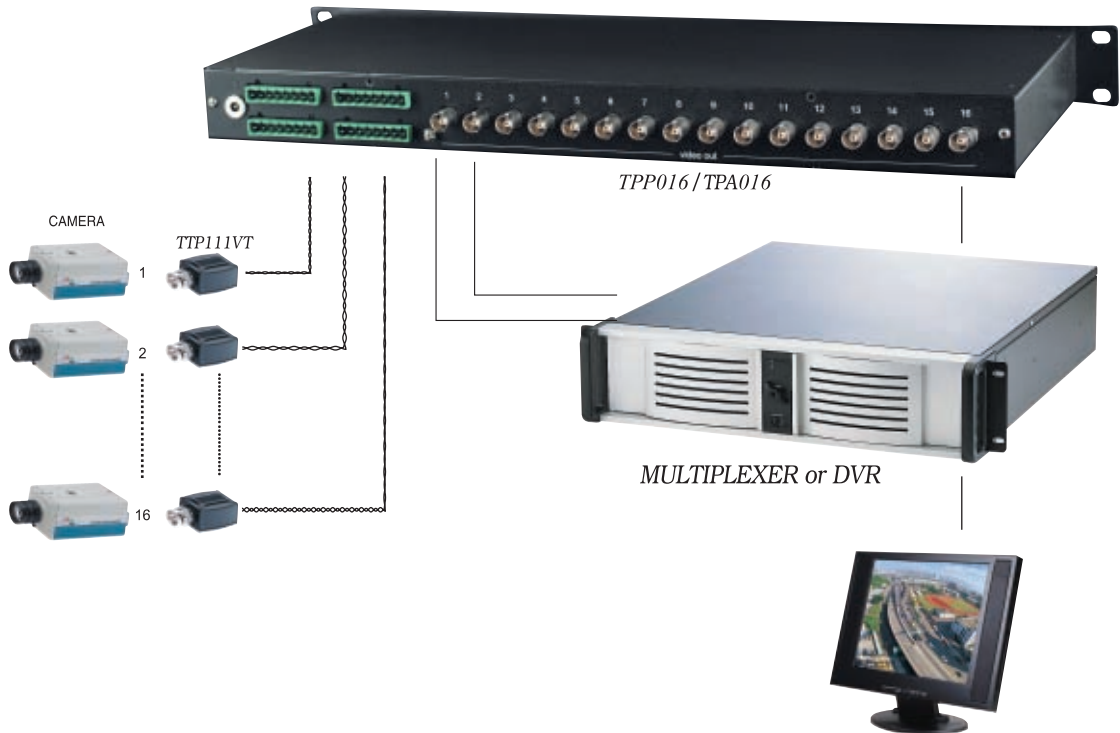

Using 8 or 16 receiver 1U panel on monitoring station, Professional 1U panel could reside in the same rack as other equipment, such as switcher, multiplexer, DVR...etc.

Building or Large CCTV installation with Rack Cabinet

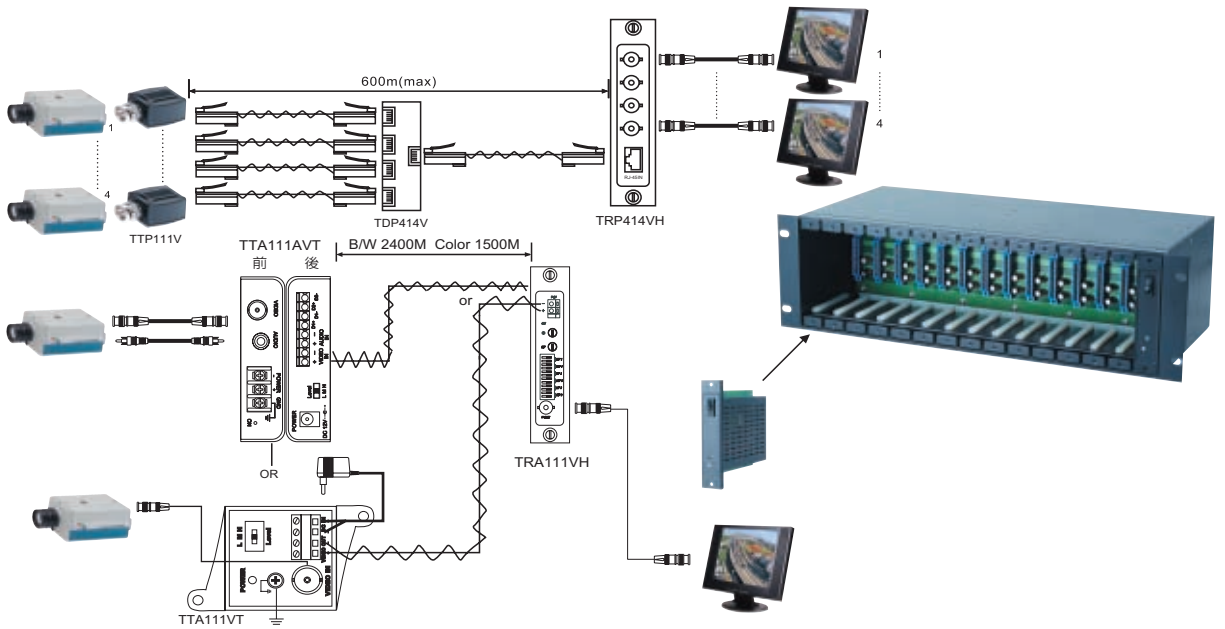

Using rack card type, could insert passive or active receiver card at TRN012 Rack Cabinet, the maximum receiving channel could up to 60 channels (passive).

Multimedia AV Application

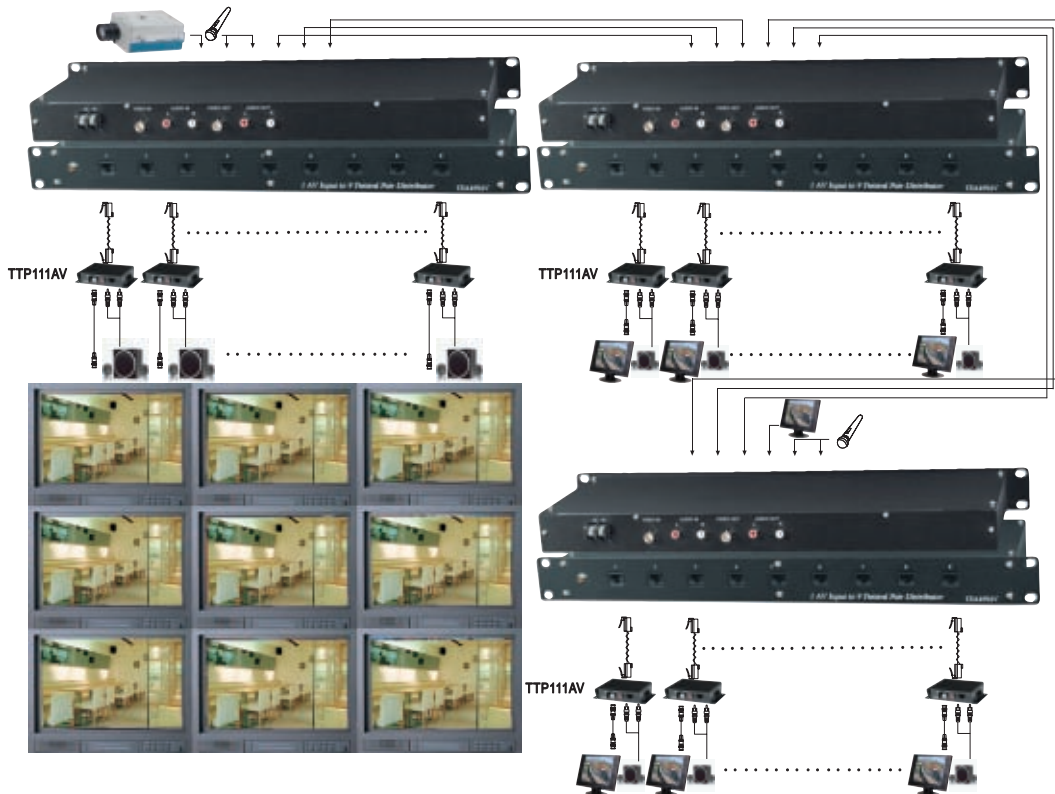

Excellent for school education system, AV multimedia, TV wall Application.

Twisted Pair Transmission Application

